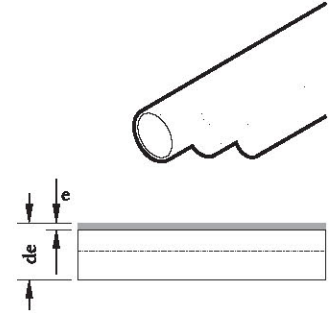

**ỐNG NƯỚC SẠCH HÀN NHIỆT (Độ dài: 4m)**  
 Polypropylene (PP-R) Pipe System (Length: 4m)

**SẢN XUẤT THEO TIÊU CHUẨN: DIN 8077 & DIN 8078; QCVN16:2017/BXD**  
 Production according to: DIN 8077 & DIN 8078; QCVN16:2017/BXD

**Ống nước lạnh PPR - PN10/PN16 - PPR pipe for cold water use - PN10/PN16**

Mã số Code	de	ø	Đơn giá Unit Price (VND/1m)	Mã số Code	de	ø	Đơn giá Unit Price (VND/1m)
PR/PN10CW20(X)	20	2.3	9.300	PR/PN16CW20(X)	20	2.8	11.500
PR/PN10CW25(X)	25	2.5	13.000	PR/PN16CW25(X)	25	3.5	16.300
PR/PN10CW32(X)	32	2.9	17.900	PR/PN16CW32(X)	32	4.4	24.500
PR/PN10CW40(X)	40	3.7	27.600	PR/PN16CW40(X)	40	5.5	39.000
PR/PN10CW50(X)	50	4.6	43.900	PR/PN16CW50(X)	50	6.9	61.800
PR/PN10CW63(X)	63	5.8	68.300	PR/PN16CW63(X)	63	8.6	100.800
PR/PN10CW75(X)	75	6.8	97.500	PR/PN16CW75(X)	75	10.3	130.000
PR/PN10CW90(X)	90	8.2	141.500	PR/PN16CW90(X)	90	12.3	181.800
PR/PN10CW110(X)	110	10.0	204.800	PR/PN16CW110(X)	110	15.1	269.800
PR/PN10CW125(X)	125	11.4	268.000	PR/PN16CW125(X)	125	17.1	358.000
PR/PN10CW140(X)	140	12.7	325.000	PR/PN16CW140(X)	140	19.2	455.000
PR/PN10CW160(X)	160	14.6	438.800	PR/PN16CW160(X)	160	21.9	585.000

**Ống nước nóng PPR - PN20/PN25 - PPR pipe for hot water use - PN20/PN25**

Mã số Code	de	ø	Đơn giá Unit Price (VND/1m)	Mã số Code	de	ø	Đơn giá Unit Price (VND/1m)
PR/PN20HW20(X)	20	3.4	14.300	PR/PN25HW20(X)	20	4.1	16.500
PR/PN20HW25(X)	25	4.2	18.800	PR/PN25HW25(X)	25	5.1	19.500
PR/PN20HW32(X)	32	5.4	29.600	PR/PN25HW32(X)	32	6.5	32.200
PR/PN20HW40(X)	40	6.7	45.500	PR/PN25HW40(X)	40	8.1	50.200
PR/PN20HW50(X)	50	8.3	68.300	PR/PN25HW50(X)	50	10.1	78.000
PR/PN20HW63(X)	63	10.5	107.300	PR/PN25HW63(X)	63	12.7	130.000
PR/PN20HW75(X)	75	12.5	157.600	PR/PN25HW75(X)	75	15.1	182.000
PR/PN20HW90(X)	90	15.0	229.200	PR/PN25HW90(X)	90	18.1	265.500
PR/PN20HW110(X)	110	18.3	339.600	PR/PN25HW110(X)	110	22.1	338.000
PR/PN20HW125(X)	125	20.8	418.300	PR/PN25HW125(X)	125	25.1	485.900
PR/PN20HW140(X)	140	23.3	524.800	PR/PN25HW140(X)	140	28.1	609.500
PR/PN20HW160(X)	160	26.6	717.300	PR/PN25HW160(X)	160	32.1	796.300

**PHỤ KIỆN ỐNG NƯỚC SẠCH HÀN NHIỆT**
**Zắc co - Socket unions**

Mã số Code	Kích cỡ Size (D)	L	L1	D1	H	Đơn giá Unit Price (VND)
FPR/UA20(X)	20	17.5	17.7	44.5	49.9	15.500
FPR/UA25(X)	25	19.7	18.5	55.5	51.7	22.900
FPR/UA32(X)	32	23.0	23.0	66.5	64.0	32.900
FPR/UA40(X)	40	26.0	23.2	83.5	61.7	37.800
FPR/UA50(X)	50	30.0	30.4	96	74.7	56.800
FPR/UA63(X)	63	39.4	37.2	116	91.4	131.500

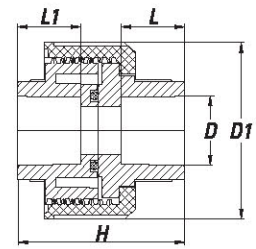
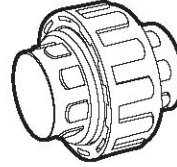
**Khớp nối trơn (măng xông) - Sockets (plain)**

Mã số Code	Kích cỡ Size (D)	L	H	Đơn giá Unit Price (VND)
FPR/C20(X)	20	16	34	1.300
FPR/C25(X)	25	18	38	2.200
FPR/C32(X)	32	20	42.5	3.300
FPR/C40(X)	40	22	47	5.200
FPR/C50(X)	50	25	53	9.500
FPR/C63(X)	63	28	62	18.800
FPR/C75(X)	75	32	66	31.500
FPR/C90(X)	90	35	74	53.300
FPR/C110(X)	110	38	83	86.500
FPR/C125(X)	125	46	98	166.300
FPR/C160(X)	160	48	105	332.500

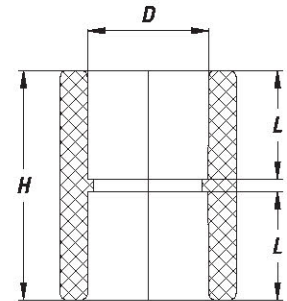
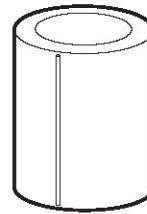
**Khớp nối ren trong - Threaded Adaptor Female**

Mã số Code	Kích cỡ Size	Rc	D	L	D1	L1	L2	H	Đơn giá Unit Price (VND)
FPR/IA20 x 1/2(X)	20 x 1/2"	1/2"	20	15	39	15	22.5	41	15.500
FPR/IA20 x 3/4(X)	20 x 3/4"	3/4"	20	15	44	15	24.5	41	16.800
FPR/IA25 x 1/2(X)	25 x 1/2"	1/2"	25	16	39	15	23	42	19.000
FPR/IA25 x 3/4(X)	25 x 3/4"	3/4"	25	16	44	15	24.5	42	21.200
FPR/IA32 x 1(X)	32 x 1"	1"	32	18	58	18	27	44	34.500
FPR/IA40 x 1(X)	40 x 1"	1"	40	-	-	-	-	-	85.000
FPR/IA40 x 1 1/4(X)	40 x 1 1/4"	1 1/4"	40	21	70	20.5	27.5	66	85.500
FPR/IA50 x 1 1/2(X)	50 x 1 1/2"	1 1/2"	50	24	80	19.5	29	68	113.500
FPR/IA63 x 2(X)	63 x 2"	2"	63	-	-	-	-	-	229.800

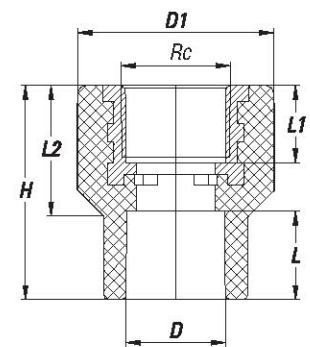
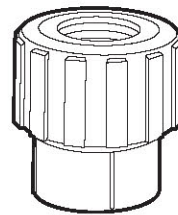

**Khớp nối ren ngoài - Threaded Adaptor Male**

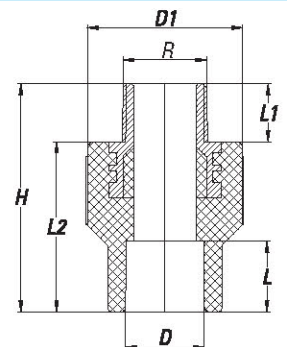
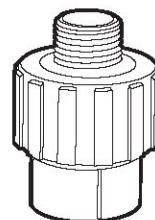
Mã số Code	Kích cỡ Size	R	D	L	D1	L1	L2	H	Đơn giá Unit Price (VND)
FPR/EA20 x 1/2(X)	20 x 1/2"	1/2"	20	15	39	15	22.5	56	19.600
FPR/EA20 x 3/4(X)	20 x 3/4"	3/4"	20	15	44	15	24.5	56	21.900
FPR/EA25 x 1/2(X)	25 x 1/2"	1/2"	25	16	39	15	23	58	22.800
FPR/EA25 x 3/4(X)	25 x 3/4"	3/4"	25	16	44	15	24.5	58	27.500
FPR/EA32 x 1(X)	32 x 1"	1"	32	18	58	18	27	70	40.500
FPR/EA40 x 1(X)	40 x 1"	1"	40	-	-	-	-	-	-
FPR/EA40 x 1 1/4(X)	40 x 1 1/4"	1 1/4"	40	21	70	20.5	27.5	84	117.600
FPR/EA50 x 1 1/2(X)	50 x 1 1/2"	1 1/2"	50	24	80	19.5	29	82.5	147.000
FPR/EA63 x 2(X)	63 x 2"	2"	63	-	-	-	-	-	249.000

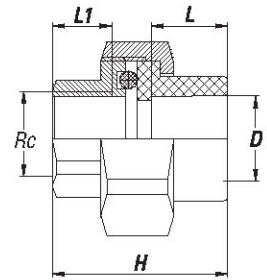
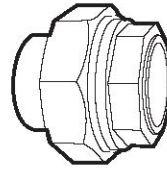

**Khớp nối vạn năng ren trong - Hexagonal Unions Adaptor Female**

Mã số Code	Kích cỡ Size	Rc	D	L	L1	H	Đơn giá Unit Price (VND)
FPR/UAF20 x 1/2(X)	20 x 1/2"	1/2"	20	16	13.3	41	37.000
FPR/UAF25 x 3/4(X)	25 x 3/4"	3/4"	25	17	14.5	44	59.200
FPR/UAF32 x 1(X)	32 x 1"	1"	32	20	16.5	50	86.800
FPR/UAF40 x 1 1/4(X)	40 x 1 1/4"	1 1/4"	40	20	53	52	112.600
FPR/UAF50 x 1 1/2(X)	50 x 1 1/2"	1 1/2"	50	25	20	58	177.600
FPR/UAF63 x 2(X)	63 x 2"	2"	63	28	22	75	247.800



**Khớp nối vạn năng ren ngoài - Hexagonal Unions Adaptor Male**

Mã số Code	Kích cỡ Size	R	D	L	L1	H	Đơn giá Unit Price (VND)
FPR/UAM20 x 1/2(X)	20 x 1/2"	1/2"	20	16	14	54	39.500
FPR/UAM25 x 3/4(X)	25 x 3/4"	3/4"	25	17	15	56	61.500
FPR/UAM32 x 1(X)	32 x 1"	1"	32	20	16.5	66	96.600
FPR/UAM40 x 1 1/4(X)	40 x 1 1/4"	1 1/4"	40	23	20	72	118.200
FPR/UAM50 x 1 1/2(X)	50 x 1 1/2"	1 1/2"	50	19	23	80	189.900
FPR/UAM63 x 2(X)	63 x 2"	2"	63	28	26	97	267.600

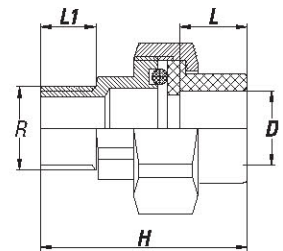
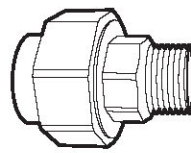

**Cút thu (côn thu) - Reducing Sockets (plain)**

Mã số Code	Kích cỡ Size	D	L	D1	L1	H	Đơn giá Unit Price (VND)
FPR/RC25x20(X)	25x20	20	15	25	16	37	2.000
FPR/RC32x20(X)	32x20	20	15	32	18	42.5	2.800
FPR/RC32x25(X)	32x25	25	16	32	18	42	2.800
FPR/RC40x20(X)	40x20	20	15	40	21	49	4.300
FPR/RC40x25(X)	40x25	25	16	40	21	48	4.300
FPR/RC40x32(X)	40x32	32	18	40	21	47	4.300
FPR/RC50x20(X)	50x20	20	15	50	24	56	7.800
FPR/RC50x25(X)	50x25	25	16	50	24	57	7.800
FPR/RC50x32(X)	50x32	32	18	50	24	55	7.800
FPR/RC50x40(X)	50x40	40	21	50	24	53	7.800
FPR/RC63x20(X)	63x20	20	-	63	-	-	12.900
FPR/RC63x25(X)	63x25	25	16	63	28	70	14.900
FPR/RC63x32(X)	63x32	32	18	63	28	65	14.900
FPR/RC63x40(X)	63x40	40	21	63	28	63.5	14.900
FPR/RC63x50(X)	63x50	50	24	63	28	61.5	14.900
FPR/RC75x40(X)	75x40	40	23	75	35	65	27.800
FPR/RC75x50(X)	75x50	50	23	75	30	63	27.800
FPR/RC75x63(X)	75x63	63	27	75	30	63	27.800
FPR/RC90x40(X)	90x40	40	23	90	41	72	38.600
FPR/RC90x50(X)	90x50	50	26	90	40	73	38.600
FPR/RC90x63(X)	90x63	63	27	90	35	71	49.200
FPR/RC90x75(X)	90x75	75	31	90	36	74	49.200
FPR/RC110x50(X)	110x50	50	28	110	43	84	75.000
FPR/RC110x63(X)	110x63	63	27	110	43	86	100.900
FPR/RC110x75(X)	110x75	75	34	110	44	87	100.900
FPR/RC110x90(X)	110x90	90	38	110	43	89	100.900
FPR/RC125x90(X)	125x90	90	38	125	47	147	108.500
FPR/RC160x110(X)	160x110	110	44	160	49	105	342.300

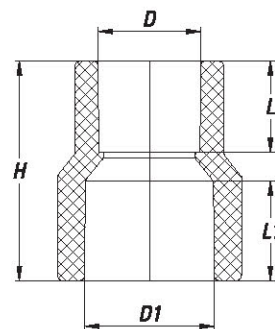
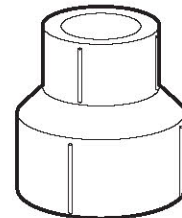

**Nối góc 45° - Elbow 45°**

Mã số Code	Kích cỡ Size (D)	L	Z	Đơn giá Unit Price (VND)
FPR/45E20(X)	20	17	22	2.000
FPR/45E25(X)	25	18.5	24.6	3.200
FPR/45E32(X)	32	20	28	4.800
FPR/45E40(X)	40	22	32	9.500
FPR/45E50(X)	50	27.5	39.5	18.000
FPR/45E63(X)	63	29	42.5	41.200
FPR/45E75(X)	75	32	49	63.500
FPR/45E90(X)	90	35	56	75.500
FPR/45E110(X)	110	42	58	131.500
FPR/45E125(X)	125	47	-	-
FPR/45E160(X)	160	49	83	205.800

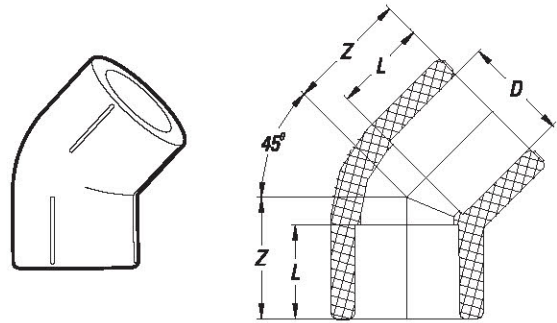

**Nối góc 90° - Elbow 90°**

Mã số Code	Kích cỡ Size (D)	L	Z	Đơn giá Unit Price (VND)
FPR/90E20(X)	20	16	27	2.500
FPR/90E25(X)	25	18	31	3.200
FPR/90E32(X)	32	20	36.5	5.500
FPR/90E40(X)	40	22	43	9.000
FPR/90E50(X)	50	13.3	49.3	15.800
FPR/90E63(X)	63	28	59	48.300
FPR/90E75(X)	75	32	71	63.000
FPR/90E90(X)	90	35	80	97.200
FPR/90E110(X)	110	42	95	198.000
FPR/90E125(X)	125	47	109	321.000
FPR/90E160(X)	160	48	130	641.900

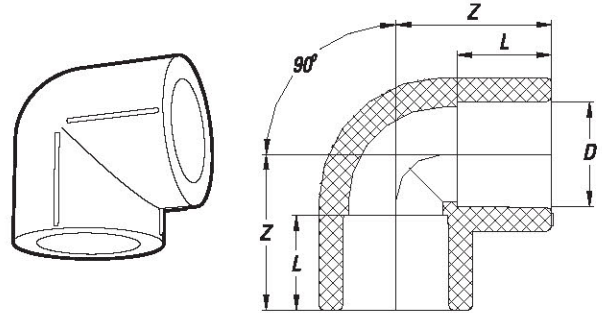

**Nối góc 90° ren trong- Female Elbow 90°**

Mã số Code	Kích cỡ Size	Rc	D	L	Z	D1	L1	Z1	Đơn giá Unit Price (VND)
FPR/IT90E20 x 1/2(X)	20 x 1/2"	1/2"	20	15	28	39	15	38	17.300
FPR/IT90E25 x 1/2(X)	25 x 1/2"	1/2"	25	16	31.5	40	15	38	19.600
FPR/IT90E25 x 3/4(X)	25 x 3/4"	3/4"	25	16	31.5	44	15	38	26.500
FPR/IT90E32 x 3/4(X)	32 x 3/4"	3/4"	32	-	-	-	-	-	44.000
FPR/IT90E32 x 1(X)	32 x 1"	1"	32	18	40	61	18	60	48.800

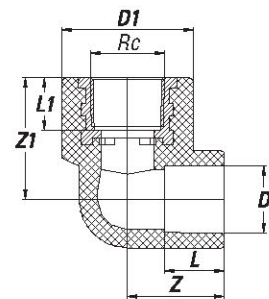
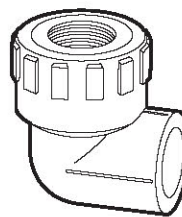

**Nối góc 90° ren ngoài - Male Elbow 90°**

Mã số Code	Kích cỡ Size	R	D	L	Z	D1	L1	Z1	Đơn giá Unit Price (VND)
FPR/ET90E20 x 1/2(X)	20 x 1/2"	1/2"	20	15	28	39	15	38	24.300
FPR/ET90E25 x 1/2(X)	25 x 1/2"	1/2"	25	16	31.5	40	15	38	27.500
FPR/ET90E25 x 3/4(X)	25 x 3/4"	3/4"	25	16	31.5	44	15	38	32.500
FPR/ET90E32 x 3/4(X)	32 x 3/4"	3/4"	32	-	-	-	-	-	48.500
FPR/ET90E32 x 1(X)	32 x 1"	1"	32	18	40	61	27	50	51.800

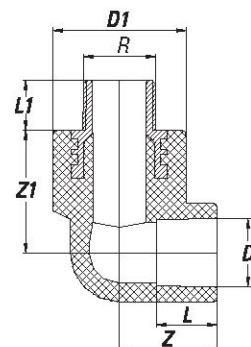
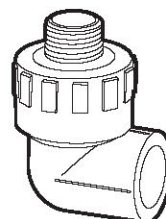

**Cút T - Loại không đồng cỡ (thu nhỏ) - Tees 90° (reducing)**

Mã số Code	Kích cỡ Size	D	L	Z	D1	L1	H	Đơn giá Unit Price (VND)
FPR/RT25x20(X)	25x20	20	16	29.5	25	17	59.5	4.300
FPR/RT32x20(X)	32x20	20	16	34	32	20	61.2	7.600
FPR/RT32x25(X)	32x25	25	18.5	35.5	32	20	67	7.600
FPR/RT40x20(X)	40x20	20	16	38	40	22	67	16.600
FPR/RT40x25(X)	40x25	25	17	38	40	22	71	16.600
FPR/RT40x32(X)	40x32	32	20	41	40	22	80	16.600
FPR/RT50x20(X)	50x20	20	16	42	50	25	82	29.200
FPR/RT50x25(X)	50x25	25	19	45	50	25	80	29.200
FPR/RT50x32(X)	50x32	32	25	36.5	50	20	89	29.200
FPR/RT50x40(X)	50x40	40	22	48.5	50	26	96	29.200
FPR/RT63x20(X)	63x20	20	16	48.5	63	20	80	43.600
FPR/RT63x25(X)	63x25	25	19	50	63	28	90	51.300
FPR/RT63x32(X)	63x32	32	22	52	63	28	92	51.300
FPR/RT63x40(X)	63x40	40	20	51.5	63	28	98	51.300
FPR/RT63x50(X)	63x50	50	26	59	63	30	129	51.300
FPR/RT75x25(X)	75x25	25	18	98	75	59	94	59.500
FPR/RT75x32(X)	75x32	32	20	98	75	59	100	70.300
FPR/RT75x40(X)	75x40	40	22	99.5	75	60	108	70.300
FPR/RT75x50(X)	75x50	50	26	99.5	75	65	118	75.500
FPR/RT75x63(X)	75x63	63	29	99.5	75	70	130	75.500
FPR/RT90x40(X)	90x40	40	22	119	90	69	120	96.800
FPR/RT90x50(X)	90x50	50	26	119	90	73.5	129	110.300
FPR/RT90x63(X)	90x63	63	31	119	90	75.5	142	118.500
FPR/RT90x75(X)	90x75	75	32.5	119	90	80	154	130.300
FPR/RT110x50(X)	110x50	50	26	143	110	90	146	163.200
FPR/RT110x63(X)	110x63	63	34	144	110	85	156	187.800
FPR/RT110x75(X)	110x75	70	39	145	110	92	165	187.800
FPR/RT110x90(X)	110x90	90	42	145	110	95	180	187.800
FPR/RT125x90(X)	125x90	90	38	150	125	151	207	220.000
FPR/RT160x63(X)	160x63	63	-	-	160	-	-	230.300
FPR/RT160x75(X)	160x75	75	-	-	160	-	-	250.800
FPR/RT160x90(X)	160x90	90	-	-	160	-	-	282.000
FPR/RT160x110(X)	160x110	110	43	172	160	50	214	309.600

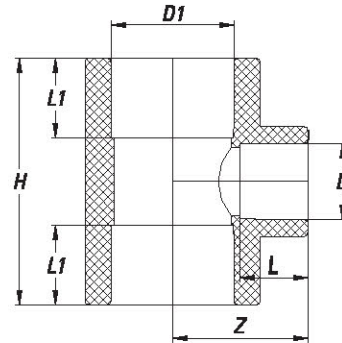
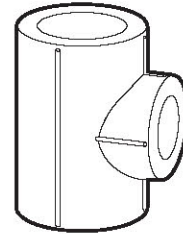

**Cút T - Loại đồng cỡ - Tees 90°**

Mã số Code	Kích cỡ Size (D)	L	Z	H	Đơn giá Unit Price (VND)
FPR/ET20(X)	20	16	26.2	52.5	2.800
FPR/ET25(X)	25	18	31	62	4.300
FPR/ET32(X)	32	20	36.5	73	7.200
FPR/ET40(X)	40	22.5	43	86	11.000
FPR/ET50(X)	50	26	59	103.5	21.600
FPR/ET63(X)	63	28	80	123	54.300
FPR/ET75(X)	75	32	93	142	81.500
FPR/ET90(X)	90	35	104	163	126.600
FPR/ET110(X)	110	44	101	203	196.000
FPR/ET125(X)	125	46.5	110.5	222	416.600
FPR/ET160(X)	160	49	130	263	763.800

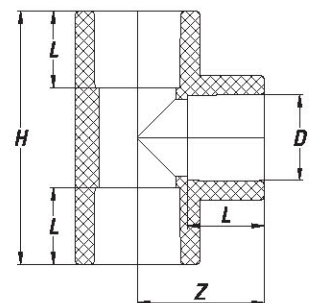
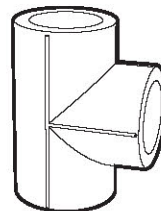

**Cút T - Loại có ren trong - Threaded Tees Female**

Mã số Code	Kích cỡ Size	Rc	D	L	D1	L1	Z1	H	Đơn giá Unit Price (VND)
FPR/TT20 x 1/2(X)	20 x 1/2"	1/2"	20	15	39	15	37	52	17.500
FPR/TT25 x 1/2(X)	25 x 1/2"	1/2"	25	16	40	15	38	60	18.600
FPR/TT25 x 3/4(X)	25 x 3/4"	3/4"	25	16	44	15	38.5	63	27.200
FPR/TT32 x 3/4(X)	32 x 3/4"	3/4"	32	-	-	-	-	-	58.800
FPR/TT32 x 1(X)	32 x 1"	1"	32	18	61	18	47	80.5	59.300

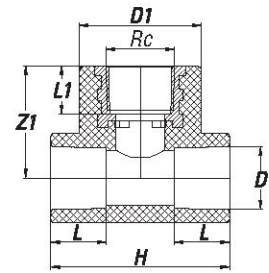
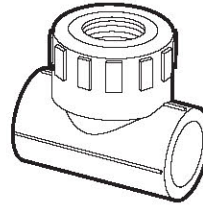
**Cút T - Loại có ren ngoài - Threaded Tees Male**

Mã số Code	Kích cỡ Size	R	D	L	D1	L1	Z1	H	Đơn giá Unit Price (VND)
FPR/ETT20 x 1/2(X)	20 x 1/2"	1/2"	20	15	39	15	37	52	21.500
FPR/ETT25 x 1/2(X)	25 x 1/2"	1/2"	25	16	40	15	38	60	23.300
FPR/ETT25 x 3/4(X)	25 x 3/4"	3/4"	25	16	44	15	38.5	63	28.200
FPR/ETT32 x 3/4(X)	32 x 3/4"	3/4"	32	-	-	-	-	-	58.800
FPR/ETT32 x 1(X)	32 x 1"	1"	32	18	61	18	47	80.5	59.200

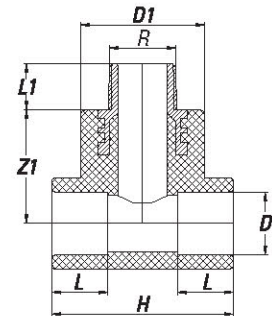
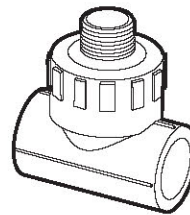
**Nút bịt - Cap**

Mã số Code	Kích cỡ Size (D)	L	H	Đơn giá Unit Price (VND)
FPR/CAP20(X)	20	21	25	1.200
FPR/CAP25(X)	25	24	28	2.000
FPR/CAP32(X)	32	26	32	2.800
FPR/CAP40(X)	40	26	34	4.000
FPR/CAP50(X)	50	26	36	7.600
FPR/CAP63(X)	63	28.5	39	12.800
FPR/CAP75(X)	75	35	48.5	65.300
FPR/CAP90(X)	90	42	56.8	73.500
FPR/CAP110(X)	110	-	-	80.900
FPR/CAP160(X)	160	-	-	83.500

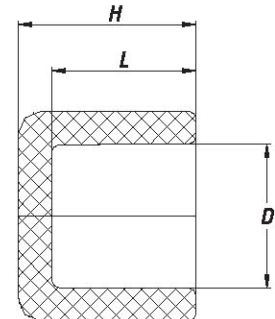
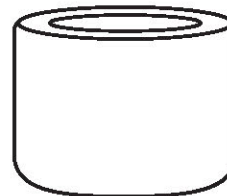
**Nút bịt ren ngoài - Screw Cap**

Mã số Code	Kích cỡ Size (R)	L	S	H	Đơn giá Unit Price (VND)
FPR/SCAP1/2(X)	1/2"	12	22	21	3.600
FPR/SCAP3/4(X)	3/4"	17	30	28	3.800

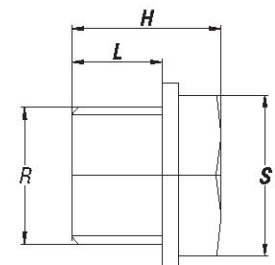
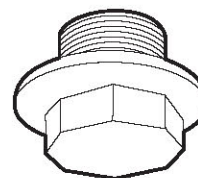

**Ống cong (ống cầu vồng) - Cross-over pipe**

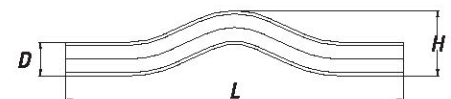
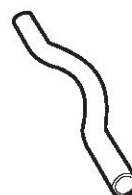
Mã số Code	Kích cỡ Size	H	L	Đơn giá Unit Price (VND)
FPR/COP20(X)	20	50	140	8.000
FPR/COP25(X)	25	50	141	15.900
FPR/COP32(X)	32	50	142	27.800

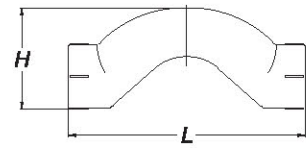

**Ống tránh - Cross-over sockets**

Mã số Code	Kích cỡ Size	H	L	Đơn giá Unit Price (VND/cái)
FPR/COS20(X)	20	47	106	7.600
FPR/COS25(X)	25	56	131	11.500
FPR/COS32(X)	32	67	147	23.900
FPR/COS40(X)	40	80	179	38.300
FPR/COS50(X)	50	102	212	70.900

**Vòng mỏng xông (mặt bích nhựa) - Flange**

Mã số Code	Kích cỡ Size (D)	L	D1	H	Đơn giá Unit Price (VND)
FPR/FL20(X)	20	16	34	24	5.200
FPR/FL25(X)	25	17	40	22	5.800
FPR/FL32(X)	32	20	49	27	9.000
FPR/FL40(X)	40	22	77	27	11.000
FPR/FL50(X)	50	25	85	30	12.200
FPR/FL63(X)	63	29	107	32	15.900
FPR/FL75(X)	75	33	121	40	26.500
FPR/FL90(X)	90	34.5	135	44	39.800
FPR/FL110(X)	110	45	169	54	59.500
FPR/FL160(X)	160	-	-	-	114.600

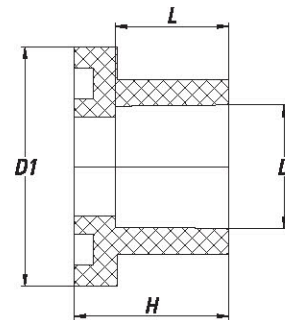
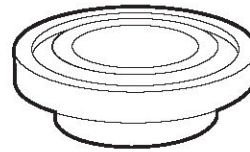
**Kẹp đỡ ống - Pipe Single Screw Clip**

Mã số Code	Kích cỡ Size	D	H	Đơn giá Unit Price (VND)
FPR/PSC20(X)	20	26	29	2.500
FPR/PSC25(X)	25	31	34	3.600
FPR/PSC32(X)	32	40	59	4.200
FPR/PSC40(X)	40	41	46	5.500
FPR/PSC50(X)	50	-	-	7.300
FPR/PSC63(X)	63	67	82	9.200

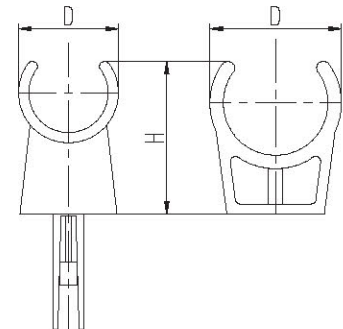
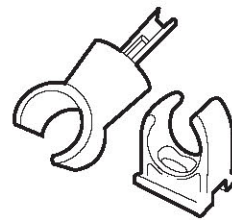
**Van tay gạt có ren trong - Ball Valve Threaded Female**

Mã số Code	Kích cỡ Size	D	H	Đơn giá Unit Price (VND)
FPR/BVF20 x 1/2(X)	20 x 1/2"	20	67	103.500
FPR/BVF25 x 3/4(X)	25 x 3/4"	25	75	129.500
FPR/BVF32 x 1(X)	32 x 1"	32	-	147.900
FPR/BVF40 x 1 1/4(X)	40 x 1 1/4"	40	-	234.900
FPR/BVF50 x 1 1/2(X)	50 x 1 1/2"	50	-	405.300
FPR/BVF63 x 2(X)	63 x 2"	63	-	620.800

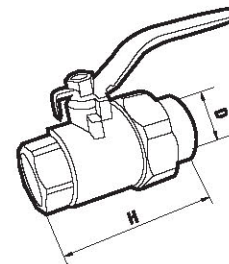

**Van khóa nhanh - Quick Valve**

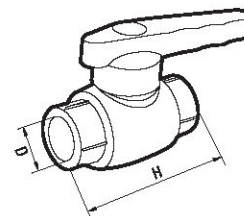
Mã số Code	Kích cỡ Size (D)	H	Đơn giá Unit Price (VND)
FPR/BVF20(X)	20	68	103.500
FPR/BVF25(X)	25	75	129.500
FPR/BVF32(X)	32	84	147.900
FPR/BVF40(X)	40	101	234.900
FPR/BVF50(X)	50	118	405.300
FPR/BVF63(X)	63	141	620.800

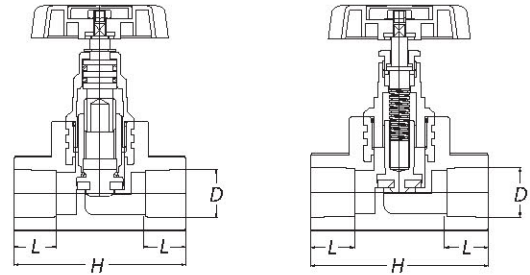
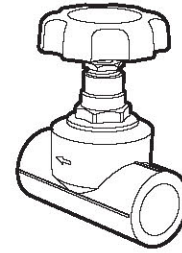

**Van tay vận - Stop Valve**

Mã số Code	Kích cỡ Size (D)	L	H	Đơn giá Unit Price (VND)
FPR/SV20(X)	20	16.5	70.5	60.800
FPR/SV25(X)	25	18	85	82.500
FPR/SV32(X)	32	20.2	87.7	95.000
FPR/SV40(X)	40	22.3	96	147.500
FPR/SV50(X)	50	26	113	250.200
FPR/SV63(X)	63	29	122	268.800

**Van cửa - Gate Valve**

Mã số Code	Kích cỡ Size (D)	L	H	H1	Đơn giá Unit Price (VND)
FPR/BV20(X)	20	16	65	75	81.800
FPR/BV25(X)	25	18.5	75	83	93.900
FPR/BV32(X)	32	20.5	78	87	134.800
FPR/BV40(X)	40	23	91	102	226.800
FPR/BV50(X)	50	26	105	111	353.800
FPR/BV63(X)	63	28	129	124	545.000

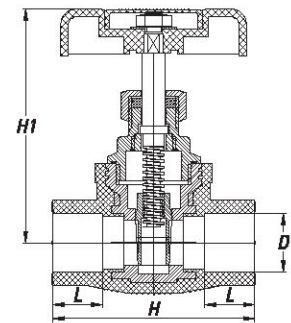
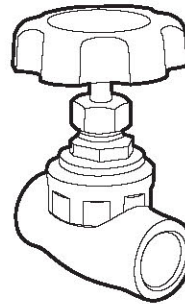
**Máy hàn ống - Electric Welding Device**

Mã số Code	Đơn giá Unit Price (VND)
PHL-S600	1.056.000
PHL-S800/900W	1.582.000
PHL-S1500	2.437.000

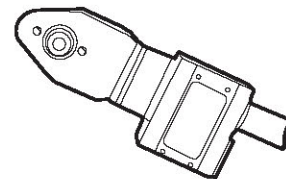
**Kìm cắt ống - Pipe Shears**

Mã số Code	Kích cỡ Size	Đơn giá Unit Price (VND)
PPR 1-5/8	1-5/8"	440.000

